



THE UNIVERSITY *of* EDINBURGH

Edinburgh Research Explorer

15.73 Gb/s Visible Light Communication with off-the-shelf LEDs

Citation for published version:

Bian, R, Tavakkolnia, I & Haas, H 2019, '15.73 Gb/s Visible Light Communication with off-the-shelf LEDs', *Journal of Lightwave Technology*. <https://doi.org/10.1109/JLT.2019.2906464>

Digital Object Identifier (DOI):

[10.1109/JLT.2019.2906464](https://doi.org/10.1109/JLT.2019.2906464)

Link:

[Link to publication record in Edinburgh Research Explorer](#)

Document Version:

Peer reviewed version

Published In:

Journal of Lightwave Technology

General rights

Copyright for the publications made accessible via the Edinburgh Research Explorer is retained by the author(s) and / or other copyright owners and it is a condition of accessing these publications that users recognise and abide by the legal requirements associated with these rights.

Take down policy

The University of Edinburgh has made every reasonable effort to ensure that Edinburgh Research Explorer content complies with UK legislation. If you believe that the public display of this file breaches copyright please contact openaccess@ed.ac.uk providing details, and we will remove access to the work immediately and investigate your claim.



15.73 Gb/s Visible Light Communication with off-the-shelf LEDs

Rui Bian*, Iman Tavakkolnia*, and Harald Haas

Abstract—Visible light communication (VLC) can provide high speed data transmission that could alleviate the pressure on the conventional radio frequency (RF) spectrum with the looming capacity crunch for digital communication systems. In this paper, we present experimental results of a VLC system with a data rate of 15.73 Gb/s after applying forward error correction (FEC) coding over a 1.6 m link. Wavelength division multiplexing (WDM) is utilized to efficiently modulate four wavelengths in the visible light spectrum. Four single color low-cost commercially available light emitting diodes (LEDs) are chosen as light sources. This confirms the feasibility and readiness of VLC for high data rate communication. Orthogonal frequency division multiplexing (OFDM) with adaptive bit loading is used. The system with the available components is characterized and its parameters, such as LED driving points and OFDM signal peak-to-peak scaling factor, are optimized. To the best of our knowledge, this is the highest data rate ever reported for LED-based VLC systems.

Index Terms—Light Fidelity (LiFi), Orthogonal frequency division multiplexing (OFDM), Wavelength division multiplexing (WDM), Visible light communication (VLC), Experimental demonstration, off-the-shelf component.

I. INTRODUCTION

IT is widely accepted that new spectrum is required to ensure that the exponentially growing demand for mobile data traffic, which is exacerbated by the emerging machine-type communication, is met. Recent studies highlight that it will be increasingly difficult to allocate new radio frequency (RF) spectrum to future wireless services due to the limited global availability [1]. Optical wireless communication (OWC) is an alternative technology that can work as a complementary system to compensate for the limited available bandwidth in the RF spectrum. OWC is favourable because of its large available unlicensed bandwidth, immunity to electromagnetic interference, inherent security and cost-effectiveness [2]. Also, the wide availability of incoherent transmitter and receiver devices makes the simple intensity modulation and direct detection (IM/DD) an efficient and straightforward option. Visible light communication (VLC) is a subclass of OWC that operates in the visible light spectrum (i.e., 390-700 nm), and thus, the existing illumination infrastructure can be exploited for data transmission as well. Recently, light-fidelity (LiFi) has been proposed as a fully networked bidirectional system which can work independently or cooperate with existing RF systems creating a hybrid network [3].

Different communication system structures have been adopted for VLC, in order to increase the achievable data rate

and spectral efficiency [3]–[6]. Orthogonal frequency division multiplexing (OFDM) is regarded as a natural choice of modulation scheme due to its high spectral efficiency and immunity to channel frequency selectivity [7]–[9]. The relatively low bandwidth of common phosphor-coated white LEDs (i.e., several MHz) causes a significant limit on the achievable data rate [10]. This limitation originates from the slow response of the yellow phosphor coating. Therefore, several single color LEDs of much larger bandwidths can be utilized for both communication and illumination. A combination of three or four colors can be used for both white illumination as well as high data rate wireless communication. This is referred to as wavelength division multiplexing (WDM), where each single color LED can be modulated independently. As a result, parallel data streams can be transmitted leading to a high communication data rate as the data rate scales linearly with the number of devices.

Over the past few years several giga-bit-per-second experimental WDM-VLC demonstrations have been reported [11]. Laser-based experiments have shown achievable data rates up to 25 Gb/s for underwater VLC [12]–[16]. However, laser-based VLC requires consideration of eye-safety and the required power reduction may significantly reduce the achievable data rates. To the best of our knowledge the highest achieved “eye-safe” data-rate is 8.8 Gb/s over 50 cm [17]. On the other hand, eye-safety is not an issue in LED-based VLC, but the available bandwidth and optical power are much smaller in LEDs. Data rates up to 7.36 Gb/s are reported with custom-made micro-sized Gallium Nitride (GaN) LEDs (μ LEDs) as the light source [18], [19]. μ LEDs have much higher bandwidth but lower output optical power compared to commercially available LEDs. The combination of several single color LEDs/ μ LEDs with WDM has enabled data rates up to 10.7 Gb/s [20]–[23].

In this paper a record data rate of 15.73 Gb/s is reported using available inexpensive off-the-shelf LEDs at a price of less than 50 US cents (\$0.50). We demonstrated that through careful system design, high data rates are achievable utilizing only off-the-shelves components. In fact, the highest LED-based aggregate data rate is achieved even compared to custom-made LEDs or μ LEDs. The link distance is 1.6 m. WDM is used with four LED colors, namely, red (R), green (G), blue (B) and yellow (Y). The single color beams are combined at the transmitter side (Tx) and separated at the receiver side (Rx) using three commercially available dichroic mirrors. Note that, unlike some works in the literature, such as [12], [20], data is simultaneously transmitted and received over four communication channels. Therefore, possible crosstalk between channels is included in the system, which makes it

*These authors contributed equally to this work.

R. Bian, I. Tavakkolnia and H. Haas are with the Li-Fi Research and Development Centre, Institute for Digital Communications, School of Engineering, University of Edinburgh, Edinburgh, EH9 3FD, UK. e-mail:{r.bian, i.tavakkolnia, h.haas}@ed.ac.uk

more close to practical applications. Moreover, OFDM with adaptive bit loading [24] is utilized to maximize the spectral efficiency of each LED. The chosen LEDs are designed for illumination rather than data communication, and thus, system parameters, such as LED bias points and signal peak-to-peak amplitude, should be carefully optimized to reduce the effect of LED non-linearity, which can significantly affect the performance of OFDM. Also, it is shown that the high bandwidth silicon optical receivers could be replaced by simple inexpensive receiver circuits to further decrease the cost. This alteration results in 7.67 Gb/s of data rate.

The rest of this paper is organized as follows. The data transmission and modulation scheme is explained in Section II-A. The experimental set-up and components used for the investigation are described in Section II-B. The experiment results are presented in Section III. Finally, concluding remarks are given in Section IV.

II. SYSTEM DESIGN

In this section the basics of the data transmission method and elements of the communication system are presented.

A. Data Transmission

OFDM is proved to be a spectrally efficient modulation scheme and a favourable choice in VLC [25], [26]. Among possible choices of OFDM variants for VLC, direct current biased optical OFDM (DCO-OFDM) is chosen due to its simplicity and high spectral efficiency [3]. Since IM/DD is used in VLC, the signal should be both real and non-negative. Thus, Hermitian symmetry is imposed on the symbols of a subcarrier block $X[k]_{k=1}^{N_{\text{FFT}}}$, where N_{FFT} is the number of subcarriers. This halves the number of available subcarriers for data transmission as $X^*[k] = X[N_{\text{FFT}} - k]$. Also, $X[0] = X[N_{\text{FFT}}/2] = 0$ because of the direct current (DC) bias. The resulting time domain signal is then clipped to avoid large values which increase the effect of nonlinearity or may damage the LED. WDM can be utilized including several visible light wavelengths that allow parallel transmission of OFDM data streams at each wavelength. Filters are used to separate signals at each wavelength. The corresponding channel model for i th wavelength can be expressed as

$$y_i(t) = g_i(x_i(t)) + n_i(t), \quad (1)$$

where $g_i(\cdot)$ is the overall channel response including the effects of optical channel and front-end devices. $n_i(t)$ is an additive white Gaussian noise (AWGN) comprising all noise origins, such as thermal and shot noise. It can be assumed that $g_i(x_i(t)) = h_i(t) * w_i(x_i(t))$, where $h_i(t)$ is the optical channel response and $w_i(\cdot)$ is the nonlinear distortion of the LED [27]. It is shown that this nonlinearity distortion can be modelled as a Gaussian process [28]. Usually, the LED can be assumed to be the dominant source of nonlinearity. As it will be seen in Section II-B, the nonlinearity of photoreceivers, amplifiers and other components are negligible compared to the LED.

Different phenomena in an experimental set-up affect the overall frequency response of the communication system and

make it frequency-dependent. For instance, the interference from ambient light sources or other optical wavelengths, the frequency-dependent response of front-end devices and the optical channel itself can affect the overall frequency response. Therefore, the modulation order can be selected adaptively at each subcarrier to maximize the achievable data rate at a target bit error ratio (BER) [24]. Thus, SNR estimation is required at each subcarrier prior to data transmission. The channel response and available SNR at each subcarrier, SNR_k , are estimated using pilots composed of several OFDM blocks. Details of the estimation method can be found in [12]. It should be noted that the overall communication channel is considered in this SNR estimation including all the affecting phenomena, such as attenuation, noise, crosstalk and nonlinear distortion. M_k -QAM modulation format is considered where the modulation order at each subcarrier, M_k , is determined by the available SNR and target BER. The BER of a M_k -QAM modulation format is approximated as [7]

$$\begin{aligned} \text{BER}(M_k, \text{SNR}_k) &\simeq \frac{4 \left(1 - \frac{1}{\sqrt{M_k}}\right)}{\log_2 M_k} \\ &\times \sum_{l=1}^{\min(2, \sqrt{M_k})} Q \left((2l-1) \sqrt{\frac{3\text{SNR}_k}{2(M_k-1)}} \right) \end{aligned} \quad (2)$$

where $Q(\cdot)$ is the Gaussian Q-function. Therefore, using the iterative algorithm for bit loading the modulation orders M_k are determined, and the overall data rate is given by [12]

$$R = \frac{\sum_{k=1}^{\frac{N_{\text{FFT}}}{2}} \log_2 M_k}{(N_{\text{FFT}} + N_{\text{CP}})/2B}, \quad (3)$$

where B is the single-sided modulation bandwidth of the system, and N_{CP} is the cyclic prefix size. It should be emphasized that after SNR estimation and adaptive bit loading, multiple OFDM blocks are transmitted through the communication channel according to the determined bit loading and the actual BER is then measured. This ensures that the overall BER of the system is below the target BER. In this paper, we consider a hard decision forward error correction coding (HDFEC) threshold of 3.8×10^{-3} which imposes 7% coding overhead.

B. Experimental Set-up

In this section the details of the experimental set-up are presented. As mentioned earlier, WDM using four single color LEDs is used. WDM can be realized in different structures. For instance, only bandpass filters at the receiver side may be used for detecting each wavelength individually [21], or a combination of bandpass filters at the Rx and dichroic mirrors at the Tx may be selected [12]. In this paper, dichroic mirrors are used in both Tx and Rx because the spectrum of each single color LED is large and available narrowband bandpass filters will result in significant power loss. Dichroic mirrors are basically high-pass filters which pass wavelengths larger than a certain value and reflect shorter wavelengths. Moreover, it is possible to efficiently (i.e., with minimal loss of optical power) combine and separate all four colors using the same combination of condenser lenses and dichroic mirrors respectively at Tx and Rx.

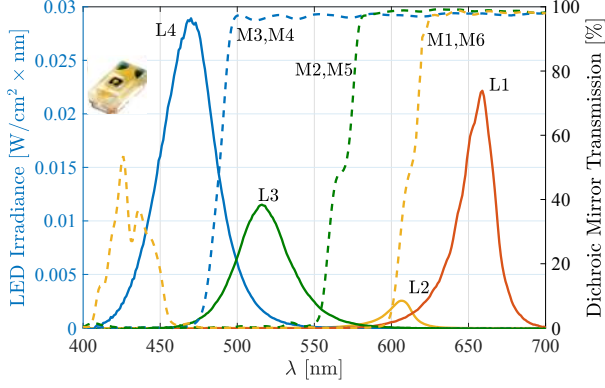

Fig. 1: LED spectra and the transmission/reflection bands of dichroic mirrors. Inset: The picture of an individual LED [29].

Fig. 1 shows optical power spectrum of LEDs used in this experiment at their nominal driving current, which are measured in the lab, and the transmission characteristics of dichroic mirrors, which are extracted from Thorlabs datasheets. These LEDs are chosen from VLM series LEDs by Vishay Semiconductors designed for small-scale high brightness applications [29]. The model number of RGBY LEDs are L1: VLMS1500-GS08, L2: VLMTG1300-GS08, L3: VLMB1500-GS08 and L4 VLMY1500-GS08, respectively. Dimensions of LEDs are $1 \times 0.5 \times 0.35$ mm for red, blue and yellow LEDs, and $1.6 \times 0.8 \times 0.8$ mm for the green LED. The scaled picture of a blue LED is shown in the inset of Fig. 1.

A crucial parameter of the experiment is the driving current point of each LED which determines the available signal amplitude range and the distortion caused by LED nonlinearity and clipping. Since these LEDs are manufactured for purposes other than data communication, their communication characteristics differ for each model. It can be seen in Fig. 2 that the output powers of LEDs are significantly different, and for instance, the output power of the yellow LED is always small. Therefore, it is essential to carefully measure the effect of different driving points and choose the optimum one. This will be studied in the next section.

The system block diagram and pictures are shown in Fig. 3. The DCO-OFDM signal generation and analysis is performed on a computer using MATLAB. Generated signals are sent to the arbitrary waveform generator (AWG: Keysight M8195A). The sampling rate of the AWG is 16 GSa/s and the resolution of the digital-to-analog (DAC) unit of the AWG is 8 bits. Each output signal from AWG is amplified by an amplifier module (Amp: Mini-Circuits ZHL-1A-S+) and fed into Bias-Tees (Mini-Circuits ZFBT-4R2GW). The Bias-Tee is used to combine the OFDM information signal with the DC bias which comes from a DC power supply. The Bias-Tee's output is connected to the LED source. Since the half-power semiangles of LEDs are wide (i.e., about 65° [29]), aspheric condenser lenses (A1-4: Thorlabs ACL4532) are used at Tx to collimate the output light of each LED. One dichroic mirror (M1: Thorlabs DLMP605L) is used to reflect the yellow signal while it passes the red signal. The transmission band for this mirror

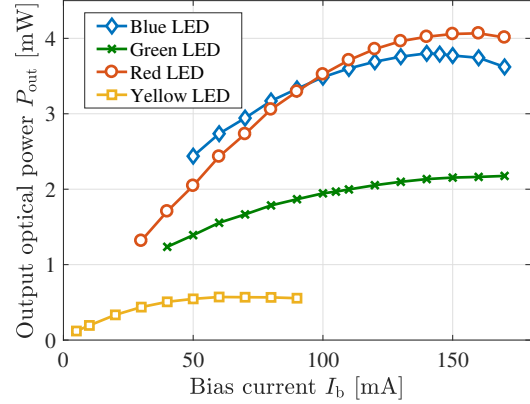

Fig. 2: Optical power output at different driving current different LED colors.

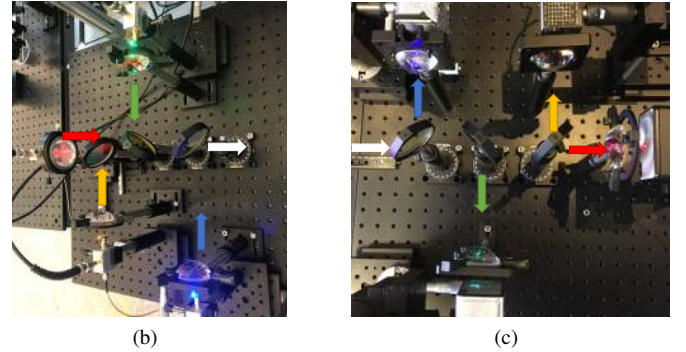
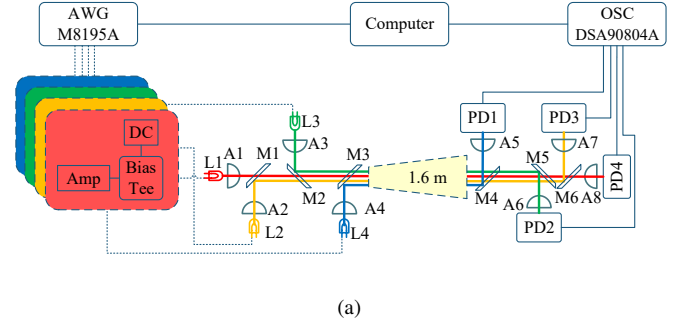

Fig. 3: (a) Block diagram of the experimental system. (b) Picture of the set-up at the transmitter side Tx. (c) Picture of the set-up at the receiver side Rx.

is 620-800 nm with a cut-off wavelength of 605 nm. Another dichroic mirror (M2: Thorlabs DLMP567L), with transmission band 584-800 nm with cut-off wavelength 567 nm, is used to reflect the green signal while it passes the other two colors. The third one, (M3: Thorlabs DMLP490L), with transmission band 505-800 nm and cut-off wavelength 490 nm, reflects the blue signal and passes the others. It should be noted that mirrors are chosen based on the measured spectrum of LEDs among commercially available dichroic mirrors.

At the receiver side at a link distance of 1.6 m, the same configuration of mirrors (M4-6) and aspheric condenser lenses (A5-8) is applied to separate each color and focus the light into the detection area of the high bandwidth positive-intrinsic-

TABLE I:
THE SUMMARY OF EXPERIMENT RESULTS.

	P_{out} [mW]	N_{act}	BER	R [Gb/s]
Red	3.52	890	0.0025	4.904
Green	1.94	887	0.0027	4.591
Blue	3.49	865	0.0036	4.796
Yellow	0.5	811	0.0028	2.925

negative (PIN) diode photo detector (PD: New Focus 1601 AC). This receiver has a 3 dB bandwidth of 1 GHz. The gain of the built-in transimpedance amplifier (TIA) is 10 V/mA. The received signal is captured by a high-speed oscilloscope (OSC: Agilent DSA90804A) and then sent back to the computer to be processed.

III. DATA TRANSMISSION RESULTS

In this section, details of the data transmission results are presented. First, the driving point for each LED is optimised. Next, the peak-to-peak scaling factor of the OFDM signal is determined. Experimental measurement results are also presented in details.

As mentioned earlier, driving points of LEDs determine achievable data rates and output optical powers. The driving point of each LED is found so that the amount of nonlinear distortion is minimized, and consequently, the available SNR for data transmission is maximized. When the driving point is selected, the OFDM signal can be scaled to fit in the linear operation region of each LED. This is performed by adjusting the maximum peak-to-peak voltage (V_{pp}) at the output of the AWG. Note that the signal is amplified after the AWG before being applied to LEDs. The overall gain from AWG to LEDs is about 13 dB including losses in components such as the bias-Tee.

The experimental set-up, as in Fig. 3, is used for driving point optimization. The modulation bandwidth is 1GHz, and the number of subcarriers is 1024. First, the minimum possible V_{pp} of the AWG, equal to 75 mV, is chosen to minimize the nonlinearity distortion of LEDs. Next, the bias current is gradually increased, and the data rate is measured using the method explained in Section II-A. The results are shown in Fig. 4 and it can be seen that each LED demonstrates different behaviour. Maximum data rates are found at $I_b = 100$ mA for RGB LEDs and $I_b = 40$ mA for the yellow LED. The bias voltages of RGBY LEDs are, respectively, 2.38 V, 3.85 V, 4.01 V, and 2.15 V. At the selected operating points of LEDs, the optimum V_{pp} for each LED is also found by gradually increasing its value and measuring the data rate. The corresponding results are demonstrated in Fig. 5. The optimum values of V_{pp} are 300 mV for red, blue and yellow LEDs, and 225 mV for the green LED. Therefore, the operation point of each LED is determined which results in the highest achievable data rate.

The summary of the data rate measurement results is provided in Table I. An aggregate bit rate 16.92 G/s is achieved which reduces to 15.73 Gb/s after removing the 7% HDFEC coding overhead. It can be seen that the BER is below the threshold of 3.8×10^{-3} for all LEDs. The number of active

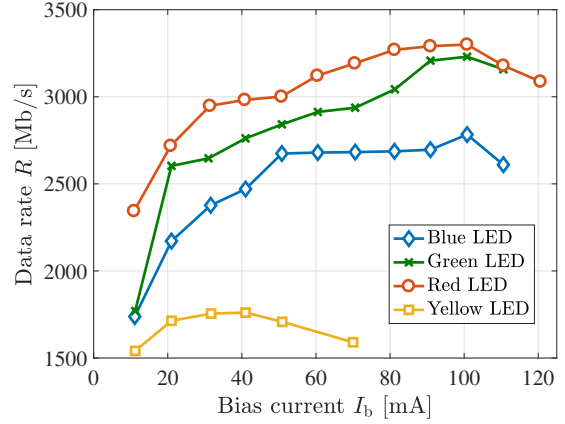

Fig. 4: The measured data rate for different I_b .

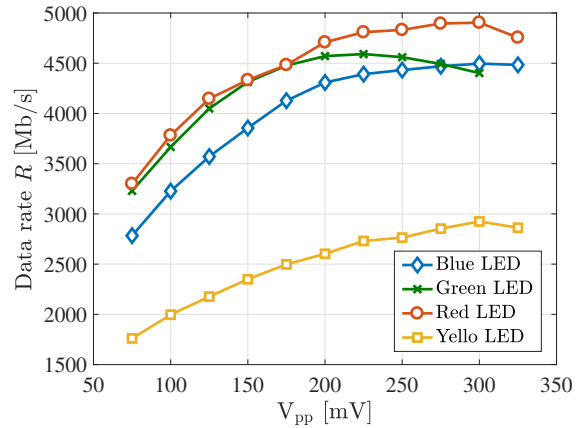

Fig. 5: The measured data rate for different V_{pp} .

subcarriers N_{act} (i.e., non-zero modulation order) and the output optical power P_{out} of each LED, at peak wavelength of its spectrum, is also included in Table I. The data rate for the white LED of the same series (VLMW1300-GS08) was also measured using the same procedure (a direct link and no dichroic mirror) for comparison with the aggregate data rate achieved with the WDM system. It was observed that only 3.53 Gb/s can be achieved at a BER of 1.2×10^{-3} . The measured output optical power of the white LED was 7.13 mW. This implies that while the output optical power of the white LED is 42% lower than the aggregate output optical powers of RGBY LEDs, its measured data rate is 79% lower. This confirms that utilizing WDM significantly increases the power efficiency of VLC systems.

The overall frequency responses of the system for each color are depicted in Fig. 7. The measured SNR and bit loading results are also shown in Fig. 6. Frequency responses are affected by all individual components of the communication system. For instance, the frequency response and the responsivity of the PD at each wavelength affect the overall frequency response. Moreover, the amount of the optical power reaching the receiver is a determining factor. The aspheric condenser lenses mainly contribute to the channel gain by guiding the light through the link, and thus, removing them

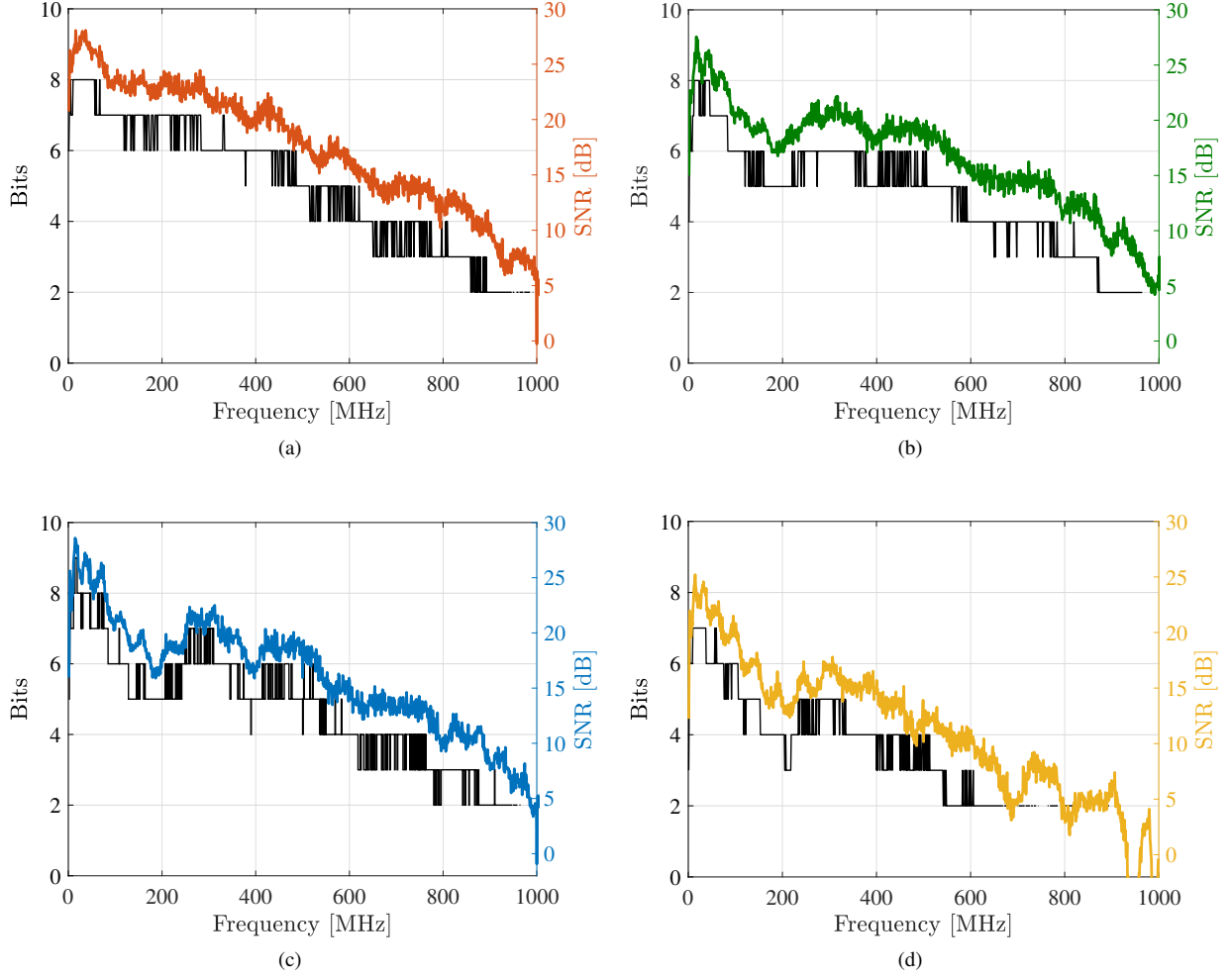

Fig. 6: (a)-(d) The measured SNR and adaptively allocated bit to each subcarrier for RGBY LEDs respectively.

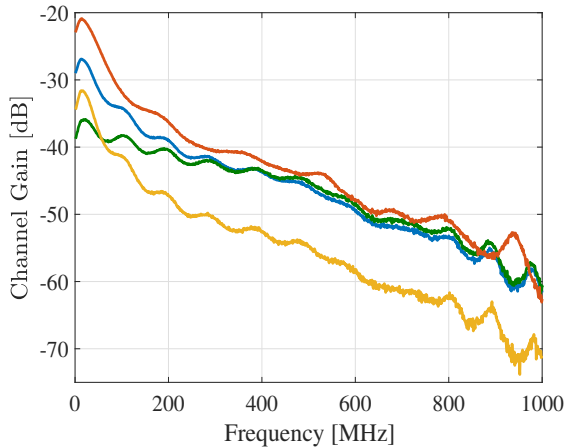

Fig. 7: The measured channel gains for four colors.

results in significant data rate loss. The optical power loss of the condenser lens material is only about 0.2 dB on average for different wavelengths. The material loss is calculated by measuring the optical power before and after the lens. Note

that using alternative components with more efficient collimation properties and less power loss can potentially increase the achievable data rate. Since LEDs and dichroic mirrors are chosen from commercially available products, their spectrum is not optimally matched, and some part of the energy is lost at the mirrors. For instance, the mirror M1 in Fig. 3 passes some part of the incident light from the yellow LED which does not reach the receiver. Also, the overlapping spectra of LEDs and non-ideal transmission characteristics of mirrors, as seen in Fig. 1, may lead to crosstalk between four communication channel. In Table II, total optical powers originating from each LED that is received by all PDs in aggregate, P_{RX} , are shown along with the percentage of optical power captured by each PD. This is measured at the peak wavelength of the spectrum of each LED by a standard optical power sensor (Thorlabs: S121C). It is observed that a significant portion of optical power is lost due to the previously mentioned reasons by comparing values of P_{RX} with total LED output powers, P_{out} in Table I. However, optical powers reaching the non-corresponding PDs are indeed small. It should be noted that any potential crosstalk or power loss is included in all data rate measurements. In a separate experiment with the same link

TABLE II: Crosstalk measurement results.

LED	P_{RX} [mW]	Optical power captured by PDs [%]			
		PD4	PD2	PD1	PD3
Red	1.18	92.30	2.46	1.52	3.72
Green	0.41	0	93.12	5.03	1.85
Blue	1.86	0	2.33	97.61	0.06
Yellow	0.072	2.56	5.40	3.86	88.18

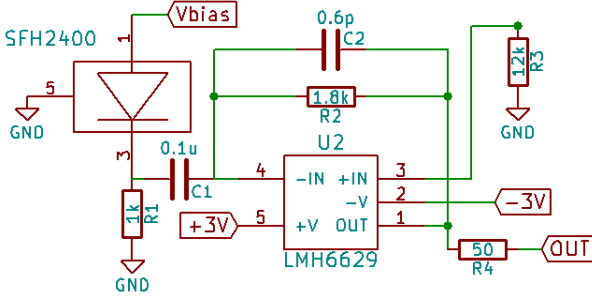

Fig. 8: The circuit design of the receiver board.

distance, the achievable data rate for single color transmission was measured. Each single LED was placed at the position of the red LED in Fig. 3 without any mirror. The obtained data rates were 5.13 Gb/s, 5.26 Gb/s, 5.22 Gb/s and 4.15 Gb/s corresponding to respective data rate decrease of 4%, 11%, 14%, and 30% when the full WDM system is used. We infer that if optimum mirrors were available, a potential data rate of 19.66 Gb/s could be achieved (i.e., 18.28 Gb/s after 7% HDFEC coding overhead reduction).

The communication system here can be further simplified by utilizing simple inexpensive receiver boards and low-cost commercially available PDs. The receiver board is fully designed and produced in the lab and replaces the high bandwidth PD (New Focus 1601 AC) mentioned previously. The board contains a silicon PIN diode PD (OSRAM SFH2400) followed by a TIA circuit based on an operational amplifier chip (TEXAS INSTRUMENTS: LMH6629). The receiver circuit is shown in Fig. 8. This circuit was developed at a cost of under 5 US Dollars (\$5). The smaller bandwidth of this circuit reduces the overall useful modulation bandwidth of the system to about 300 MHz. The measured data rates and corresponding BER are presented in Table III. In total 8.24 Gb/s (7.67 Gb/s after 7% HDFEC coding overhead reduction) is achieved. This also confirms that VLC enables high-speed communications at very low cost and hardware complexity.

IV. CONCLUSION

A WDM system with four visible light wavelengths is designed based on dichroic mirrors. Each wavelength is modulated using DCO-OFDM with adaptive bit-loading and system parameters are optimized experimentally. A data transmission rate of 15.73 Gb/s is achieved with the BER below the 7% HDFEC limit of 3.8×10^{-3} over a 1.6 m wireless link. In this paper, highest achieved data rate LED-based VLC systems is reported. Commercially available LEDs are chosen to signify the potential of being able to create high data-rate systems at low-cost and off-the-shelf optical components.

TABLE III:
THE SUMMARY OF EXPERIMENT RESULTS WITH
SELF-MADE RX BOARD.

	BER	R [Gb/s]
Red	0.0021	2.183
Green	0.0032	2.262
Blue	0.0021	2.180
Yellow	0.0033	1.618

ACKNOWLEDGMENT

Professor Haas gratefully acknowledges the support of this research by the Engineering and Physical Sciences Research Council (EPSRC) under an Established Career Fellowship grant, EP/R007101/1. He also acknowledges the financial support of his research by the Wolfson Foundation and the Royal Society.

REFERENCES

- [1] T. Cogalan and H. Haas, "Why would 5G need optical wireless communications?" in *IEEE Int. Symp. Personal Indoor Mobile Radio Commun. (PIMRC)*, Oct. 2017, pp. 1–6.
- [2] H. Elgala, R. Mesleh, and H. Haas, "Indoor optical wireless communication: potential and state-of-the-art," *IEEE Commun. Mag.*, vol. 49, no. 9, pp. 56–62, Sept. 2011.
- [3] H. Haas, L. Yin, Y. Wang, and C. Chen, "What is LiFi?" *J. Lightw. Technol.*, vol. 34, no. 6, pp. 1533–1544, Mar. 2016.
- [4] I. Tavakkolnia, C. Chen, R. Bian, and H. Haas, "Energy-efficient adaptive MIMO-VLC technique for indoor LiFi applications," in *Int. Conf. Telecommun. (ICT)*, Jun. 2018, pp. 1–6.
- [5] M. D. Soltani, X. Wu, M. Safari, and H. Haas, "Bidirectional user throughput maximization based on feedback reduction in LiFi networks," *IEEE Trans. Commun.*, vol. 66, no. 7, pp. 3172–3186, Jul. 2018.
- [6] M. D. Soltani, A. A. Purwita, Z. Zeng, H. Haas, and M. Safari, "Modeling the random orientation of mobile devices: Measurement, analysis and LiFi use case," *IEEE Trans. Commun.*, vol. 67, no. 3, pp. 2157–2172, Nov. 2019.
- [7] D. Tsonev, S. Videv, and H. Haas, "Unlocking spectral efficiency in intensity modulation and direct detection systems," *IEEE J. Sel. Areas Commun.*, vol. 33, no. 9, pp. 1758–1770, Sep. 2015.
- [8] I. Tavakkolnia, A. Yesilkaya, and H. Haas, "OFDM-based spatial modulation for optical wireless communications," in *IEEE Globecom Workshops (GC Wkshps)*, Dec. 2018, pp. 1–6.
- [9] M. D. Soltani, A. A. Purwita, I. Tavakkolnia, H. Haas, and M. Safari, "Impact of device orientation on error performance of LiFi systems," *IEEE Access*, 2018.
- [10] A. Khalid, G. Cossu, R. Corsini, P. Choudhury, and E. Ciaramella, "1-Gb/s transmission over a phosphorescent white LED by using rate-adaptive discrete multitone modulation," *IEEE Photon. J.*, vol. 4, no. 5, pp. 1465–1473, Oct. 2012.
- [11] S. Rajbhandari, J. J. McKendry, J. Hermsdorf, H. Chun, G. Faulkner, H. Haas, I. M. Watson, D. O'Brien, and M. D. Dawson, "A review of gallium nitride LEDs for multi-gigabit-per-second visible light data communications," *Semicond. Sci. Technol.*, vol. 32, no. 2, p. 023001, 2017.
- [12] D. Tsonev, S. Videv, and H. Haas, "Towards a 100 Gb/s visible light wireless access network," *Opt. Express*, vol. 23, no. 2, pp. 1627–1637, Jan. 2015.
- [13] S. Viola, M. S. Islim, S. Watson, S. Videv, H. Haas, and A. E. Kelly, "15 Gb/s OFDM-based VLC using direct modulation of 450 GaN laser diode," in *Advanced Free-Space Optical Communication Techniques and Applications III*, vol. 10437, Oct. 2017, p. 104370E.
- [14] Y.-C. Chi, Y.-F. Huang, T.-C. Wu, C.-T. Tsai, L.-Y. Chen, H.-C. Kuo, and G.-R. Lin, "Violet laser diode enables lighting communication," *Sci. Rep.*, vol. 7, no. 1, p. 10469, Sep. 2017.
- [15] T.-C. Wu, Y.-C. Chi, H.-Y. Wang, C.-T. Tsai, and G.-R. Lin, "Blue laser diode enables underwater communication at 12.4 Gbps," *Sci. Rep.*, vol. 7, p. 40480, Jan. 2017.
- [16] C.-Y. Li, H.-H. Lu, W.-S. Tsai, Z.-H. Wang, C.-W. Hung, C.-W. Su, and Y.-F. Lu, "A 5 m/25 Gbps underwater wireless optical communication system," *IEEE Photon. J.*, Jun. 2018.

- [17] T.-C. Wu, Y.-C. Chi, H.-Y. Wang, C.-T. Tsai, Y.-F. Huang, and G.-R. Lin, "Tricolor R/G/B laser diode based eye-safe white lighting communication beyond 8 Gbit/s," *Sci. Rep.*, vol. 7, no. 1, p. 11, Jan. 2017.
- [18] D. Tsonev, H. Chun, S. Rajbhandari, J. J. McKendry, S. Videv, E. Gu, M. Haji, S. Watson, A. E. Kelly, G. Faulkner *et al.*, "A 3-Gb/s single-LED OFDM-based wireless VLC link using a gallium nitride μ LED," *IEEE Photon. Technol. Lett.*, vol. 26, no. 7, pp. 637–640, Apr. 2014.
- [19] M. S. Islim, R. X. Ferreira, X. He, E. Xie, S. Videv, S. Viola, S. Watson, N. Bamiedakis, R. V. Penty, I. H. White *et al.*, "Towards 10 Gb/s orthogonal frequency division multiplexing-based visible light communication using a GaN violet micro-LED," *Photon. Res.*, vol. 5, no. 2, pp. A35–A43, Apr. 2017.
- [20] H. Chun, S. Rajbhandari, G. Faulkner, D. Tsonev, E. Xie, J. J. D. McKendry, E. Gu, M. D. Dawson, D. C. O'Brien, and H. Haas, "LED based wavelength division multiplexed 10 Gb/s visible light communications," *J. Lightw. Technol.*, vol. 34, no. 13, pp. 3047–3052, Jul. 2016.
- [21] Y. Wang, L. Tao, X. Huang, J. Shi, and N. Chi, "8-Gb/s RGBY LED-based WDM VLC system employing high-order CAP modulation and hybrid post equalizer," *IEEE Photon. J.*, vol. 7, no. 6, pp. 1–7, Dec. 2015.
- [22] X. Zhu, F. Wang, M. Shi, N. Chi, J. Liu, and F. Jiang, "10.72 Gb/s Visible Light Communication System Based On Single Packaged RGBYC LED Utilizing QAM-DMT Modulation With Hardware Pre-Equalization," in *Opt. Fiber Commun. Conf. (OFC)*. Optical Society of America, Mar. 2018, pp. M3K–3.
- [23] R. Bian, I. Tavakkolnia, and H. Haas, "10.2 Gb/s visible light communication with off-the-shelf LEDs," in *Eur. Conf. Opt. Commun. (ECOC)*, Sep. 2018, pp. 1–3.
- [24] H. E. Levin, "A complete and optimal data allocation method for practical discrete multitone systems," in *IEEE Global Telecommun. Conf. (Globecom)*, Dec. 2001, pp. 369–374.
- [25] M. Z. Afgani, H. Haas, H. Elgala, and D. Knipp, "Visible light communication using OFDM," in *Testbeds and Research Infrastructures for the Development of Networks and Communities (TRIDENTCOM)*, Mar. 2006, pp. 1–6.
- [26] J. Armstrong and A. Lowery, "Power efficient optical OFDM," *Electron. Lett.*, vol. 42, no. 6, pp. 370–372, Mar. 2006.
- [27] L. Chen, B. Krongold, and J. Evans, "Theoretical characterization of nonlinear clipping effects in IM/DD optical OFDM systems," *IEEE Trans. Commun.*, vol. 60, no. 8, pp. 2304–2312, Aug. 2012.
- [28] S. Dimitrov and H. Haas, "Information rate of OFDM-based optical wireless communication systems with nonlinear distortion," *J. Lightw. Technol.*, vol. 31, no. 6, pp. 918–929, Mar. 2013.
- [29] Vishay, "Ultrabright 0402 ChipLED," 91000 datasheet, Feb. 2017.